

WIPE™
 WIPE™ ASYM

EN: MEASUREMENT
 NO: MÅL
 SE: MÅTT
 FI: MITAT

WIPE

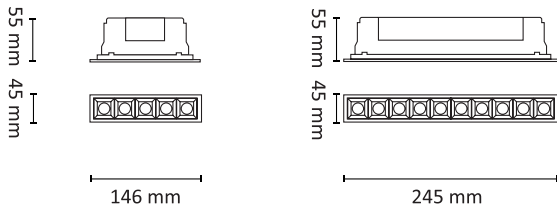

WIPE ASYM

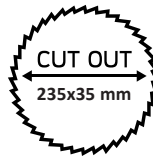
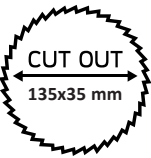
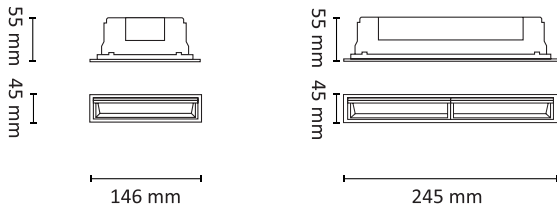

EN: MOUNTING
 NO: MONTERING
 SE: MONTERING
 FI: ASENNUS

1

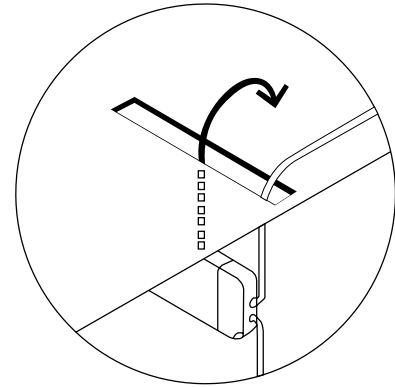

2

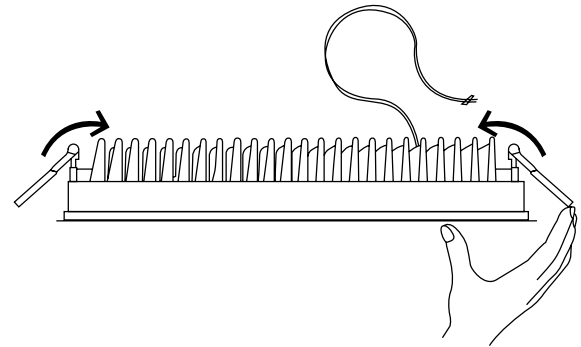

3

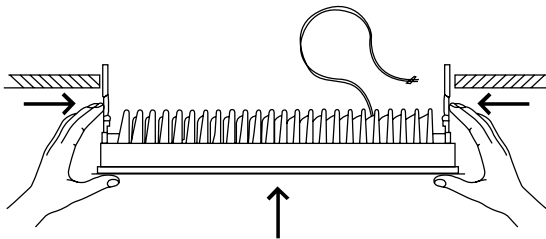

4

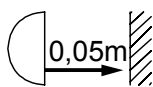
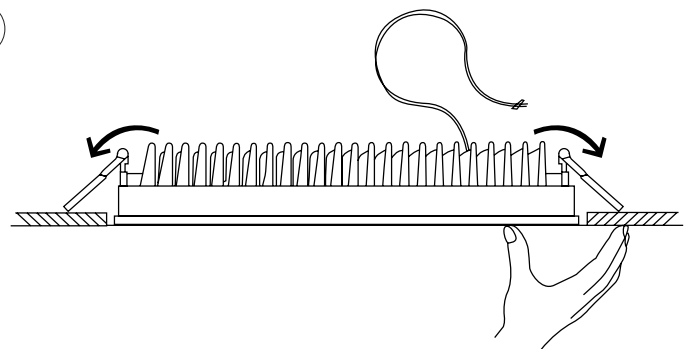

EN: Minimum distance to flammable material in the beam direction.
 NO: Minimumsavstand til brennbart materiale i armaturens stråleretning.
 SE: Minsta avstånd mellan brännbart material och lampans ljusrättning.
 FI: Vähimmäismitta lampusta palaavaan materiaaliin.

OBS!

EN: Installation must be performed by a qualified electrician.
 NO: Må installeres av autorisert el-installatør.
 SE: Måste installeras av en behörig elinstallatör.
 FI: Vain valtuutettu sähköasentaja saa asentaa.